

Machine Overhaul – Fits and Tolerances

1. Introduction

Our modern industrial society depends on international and readily available standards for measuring, interchangeable part manufacture, and mass production manufacturing. Today, most manufacturing, including that of rolling bearings, is done to the ISO System of Limits and Fits.

In broad terms, the most critical part of most rotating machines is the bearings; all the forces from rotational and process effects are transmitted through the bearings to the supporting structure. It is usually the failure of the bearings which stops the machine so it is appropriate to give the best possible attention to their installation to achieve longer running times between repairs.

In many respects the maintenance trades role has become one of “assemblers of parts” rather than repairers of machines. As such the craft skills of machinery improvement have become neglected, along with attention to detail, and replaced with a skill of replacement of the defective parts in the quickest possible time.

This session will look at

- fits and tolerances from the perspective of bearings,
- shrink fits
- assembly errors

2. Fits and Tolerances from the Perspective of Bearings

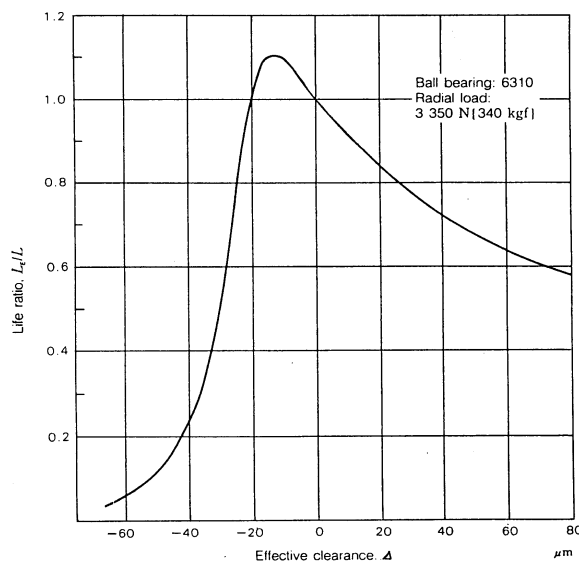

Fig. 1 Relation between effective clearance and bearing life for 6310 ball bearing

Remarks L_{ϵ} : Life in case of effective clearance $\Delta = \epsilon$
 L : Life in case of effective clearance $\Delta = 0$

A rolling bearing, considered as a machine element, will function at its most optimum level when *at operating condition* the bearing is in, or very close to, a condition of zero clearance. The operating clearance should be as small as possible for the shaft to be guided perfectly.

The figure shows the effect of clearance on the life of a bearing.

By this is meant that the load, which the bearing has been designed to transmit, and against which the bearing L10 Fatigue Lifetime (hours) has been calculated, is most optimally distributed around the circumference of the bearing inner and outer raceways, when the clearance

in the bearing is very close to, or just in, a condition of slight pre-load – *at the operating condition.*

The bearing clearance is the measurement by which one bearing ring can be displaced in relation to the other one either in a radial direction (radial clearance) or in the axial direction (axial clearance) from one position to the other. With some bearing types the radial and the axial clearances have an interdependent relationship - if one clearance is measured then the other can be known.

Time does not permit this session to do full justice to the subject and the focus will be on presenting how the information should be used to ensure that the process of fitting bearings is done in such a way that correct clearances are achieved so that life is maximised and reliability increased.

For the purposes of this session, the discussion will be limited to radial bearings, as opposed to thrust bearings.

2.1 ISO System of Limits and Fits

This requirements is set out in international standard like BS 4500, ISO 286 –1, AS 1654

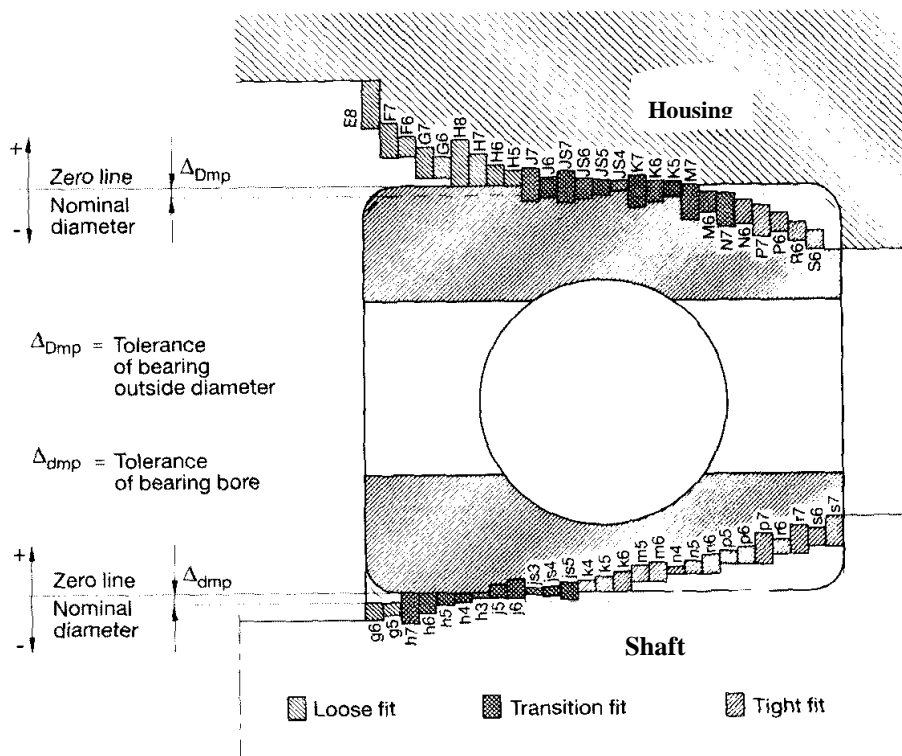

Figure 2 Principal Fits for Bearings ISO System of Limits and Fits

It allows for 28 fundamental deviations (or tolerance zones), with provision for 18 (IT01, IT0, IT1IT16) tolerance grades within each deviation (or zone), over a size range of 0 to 3150mm. The possible 28 deviations for **holes** are designated A, B, C ZC with the **shaft** deviations designated with lower case letters over the whole range; a, b, c .. zc. From this huge

range of standardised tolerances, only a small number are applicable to rolling bearing engineering.

2.2 The Fit and Clearance Selection Process

The Clearance in the bearing has a direct effect on the life of the bearing, all other factors such as lubrication, freedom from contamination etc being equal.

To arrive at the correct Clearance the following steps need to be followed;

- the Loading requirements are identified. This will determine which ring must be fitted.
- From this the Tolerances are identified and the fits are then determined.
- The fits will, in turn, determine the Clearance.

2.3 Identification of Loading Conditions

In an ideal world both the fit of the inner ring to the shaft and the outer ring to the housing would be tight fits to provide maximum support and ensure the most favourable load distribution within the bearing. However, in bearings with inseparable rings the reality is that one of these fits must be a sliding fit

- to accommodate the axial growth of the shaft due to thermal expansion, and
- to provide for assembly and disassembly.

Figure 1 below identifies which ring must be tightly fitted. Note that it is the ring which is **circumferentially loaded** that **must** be tightly fitted, regardless of whether it rotates or not.

▼ Differences between circumferential load and point load



Bearing motions	Example	Illustration	Loading conditions	Fits	Bearing motions	Example	Illustration	Loading conditions	Fits
Rotating inner ring Stationary outer ring Constant load direction	Weight suspended by the shaft		Circumferential load on inner ring	Inner ring: tight fit mandatory	Stationary inner ring Rotating outer ring Constant load direction	Automotive front wheel bearing Conveyor idler hub mounting		Point load on inner ring	Inner ring: slide fit permissible
Stationary inner ring Rotating outer ring Direction of load rotating with outer ring	Large imbalance rotating with outer ring		Point load on outer ring	Outer ring: slide fit permissible	Rotating inner ring Stationary outer ring Direction of load rotating with inner ring	Centrifuge Vibrating screen		Circumferential load on outer ring	Outer ring: tight fit mandatory

Figure 1 Selecting the Tight Fitted Ring

Having determined which ring is to be tightly fitted,

- the **Shaft Tolerance** is determined from figure 2 with the figure in brackets being the *desirable*, the other being *acceptable*.
- The **Housing Tolerance** is determined from figure 3 with the figure in brackets being the *desirable*, the other being *acceptable*.

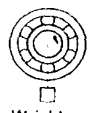
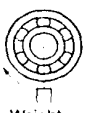
2.4 Determining the Correct Fit and Tolerance

The **tolerance grade** (ITx) is determined by the precision requirement. The normal dimensional and running precision of rolling bearings is sufficient for most applications. Where higher precision is required, eg machine tool spindles, there are other standardised tolerance classes – P4, P5 etc

Cylindrical bore radial bearings

Type of load	Bearing type	Shaft diameter	Axial displaceability Load	Tolerances
Point load on inner ring	Ball, roller and needle roller bearings	all sizes	Floating bearings with sliding inner ring	g6 (g5)
			Angular contact ball bearings and tapered roller bearings with adjusted inner ring	h6 (j6)
Circumferential load on inner ring or indeterminate load	Ball bearings	up to 40 mm	normal load	j6 (j5)
			low load	j6 (j5)
		up to 100 mm	normal and high load	k6 (k5)
			low load	k6 (k5)
		up to 200 mm	normal and high load	m6 (m5)
			low load	m6 (m5)
		over 200 mm	normal load	m6 (m5)
			high load, shocks	n6 (n5)
	Roller and needle roller bearings	up to 60 mm	low load	j6 (j5)
			normal and high load	k6 (k5)
		up to 200 mm	low load	k6 (k5)
			normal load	m6 (m5)
			high load	n6 (n5)
		up to 500 mm	normal load	m6 (n6)
high load, shocks	p6			
over 500 mm	normal load	n6 (p6)		
	high load	p6		

Figure 2 Shaft Tolerances

Radial bearings

Type of load	Axial displaceability Load	Operating conditions	Tolerances
Point load on outer ring	Floating bearing, easy displacement of outer ring	Closeness of tolerance based on required running accuracy	H7 (H6)
	Outer ring generally displaceable, angular contact ball bearings and tapered roller bearings with adjustment via outer ring	High running accuracy required	H6 (J6)
		Standard running accuracy	H7 (J7)
		External heating through shaft	G7
Circumferential load on outer ring or indeterminate load	Low load	With high running accuracy requirements K6, M6, N6, and P6	K7 (K6)
	Normal load, shocks		M7 (M6)
	High load, shocks		N7 (N6)
	High load, heavy shocks thin-walled housings		P7 (P6)

Figure 3 Housing Tolerances

2.5 Determining the Correct Clearance

The two factors affecting bearing clearance reduction are

- Radial temperature gradient
- Fits

From the non-mounted situation, clearance is reduced by the tight fit at mounting and then again during operation when the inner ring becomes warmer than the outer ring, which is usually the case. The normal clearance (clearance group, CN) is calculated in such a way that the bearing has an appropriate operating clearance under common mounting and operating conditions.

Normal fits are :	Shaft	Housing
Ball Bearings	j5...k5	H7....J7
Roller Bearings	k5...m5	H7...M7

Where there are tight fits or a temperature difference greater than 10degC between the inner and outer rings, other clearance groups are required.

- C2 Radial clearance is smaller than normal (CN)
- C3 Radial clearance is larger than normal (CN)
- C4 Radial clearance larger than C3.

The expansion of the inner ring raceway and the constriction of the outer ring raceway can be assumed to be approximately 80% and 70% of the interference, respectively.

Figure 4 shows the machining tolerances, as related to the Housing Bore and the Shaft Diameter, which are then related to the Table of ISO Basic Tolerances .

From the fits tables, go to the shaft size and the appropriate tolerance. For Normal Tolerances the

- Shaft machining tolerance is ideally IT5 but IT6 is acceptable
- Housing machining tolerance is ideally IT6 but IT7 is acceptable.

▼ Recommendations for machining bearing seats and their roughness

Tolerance class of the bearings	Bearing seat	Machining tolerance	Roughness class
Normal, P6X	Shaft	IT6 (IT5)	N5...N7
	Housing	IT7 (IT6)	N6...N8
P5	Shaft	IT5	N5...N7
	Housing	IT6	N6...N8
P4, P4S, SP	Shaft	IT4	N4...N6
	Housing	IT5	N5...N7
UP	Shaft	IT3	N3...N5
	Housing	IT4	N4...N6

Figure 4 Machining Tolerances

In machining and making the actual measurements of the shaft, and the housing bore, it is essential to be sure that the shaft and housing seats are within acceptable limits of straightness, circularity and cylindricity. It is at this stage that precision skills are brought to bear upon the final quality of the job.

The sketches below shows the taking two sets of readings along the seat, with each set having four equally spaced diametral measurements.

Additionally, there are rules governing the tolerances for positioning a second bearing seat on the shaft or in the housing, for coaxiality with the first seat.

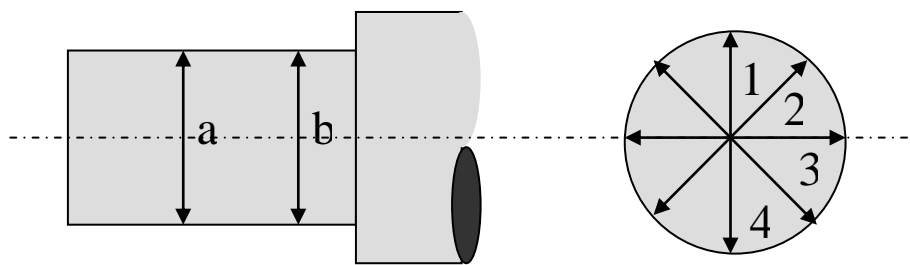

Shaft Seats

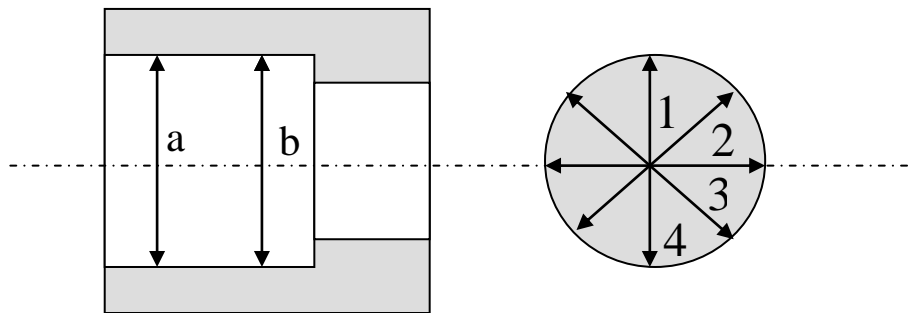

Housing Seats

Only by diligent attention to these details will the bearing be fitted in a manner appropriate to maximising its reliability, assuming there is good practice in mounting the bearing.

The following pages of notes which give an authoritative interpretation of this process by working through an example.

2.6 Shaft Quality Control for Bearing Reliability

With a micrometer the dimensions of a journal are checked for suitability to remain in service. The example is a **150mm diameter** shaft and the positions on the journal under the bearing to measure, along with the required tolerances from the bearing manufacturer that must be met.

Shaft Diameter mm		Tolerance h9 μm		Form IT5 μm
over	incl	high	low	max
18	30	0	-52	9
30	50	0	-62	11
50	80	0	-74	13
80	120	0	-87	15
120	180	0	-100	18
180	250	0	-115	20
250	315	0	-130	23

Tolerance Evaluation

	0°	45°	90°	135°	Plane Average	Required Tolerance h9
Plane A	149.98	149.99	149.98	149.99		>149.900 <150.000
Plane B	149.97	149.94	149.98	149.95		
Plane C	149.98	149.98	149.95	149.99		
Max & Min						

Shaft diameters are within tolerance

Cylindricity Evaluation

	0°	45°	90°	135°	Plane Average	Required IT Grade 5
Plane A	149.98	149.99	149.98	149.99		<0.018
Plane B	149.97	149.94	149.98	149.95		
Plane C	149.98	149.98	149.95	149.99		
Max-Min	0.01	0.05	0.03	0.04		

Shaft cylindricity is out of tolerance and the shaft is unacceptable for service

Roundness Evaluation

	0°	45°	90°	135°	Plane Max-Min	Required IT Grade 5
Plane A	149.98	149.99	149.98	149.99	0.01	<0.018
Plane B	149.97	149.94	149.98	149.95	0.04	
Plane C	149.98	149.98	149.95	149.99	0.04	

Shaft roundness is out of tolerance and the shaft is unacceptable for service

Base Plate Flatness

Base plates on which the bearing plumber blocks are mounted also need to be machined suitably flat.

	Length mm		Flatness IT5 μm	Flatness IT7 μm
	over	incl	max	max
	80	120	15	35
	120	180	18	40
	180	250	20	46
	250	315	23	62
	315	400	25	57
	400	500	27	63
	500	630	30	70
	630	800	35	80
	800	1000	40	90

Length of base (mm): _____

Width of Base (mm): _____

	Point 1	Point 2	Max-Min	Plane Average	Target IT Grade 5
Plane A					
Plane B					
Plane C					
Max-Min					

Base Plate Orientation

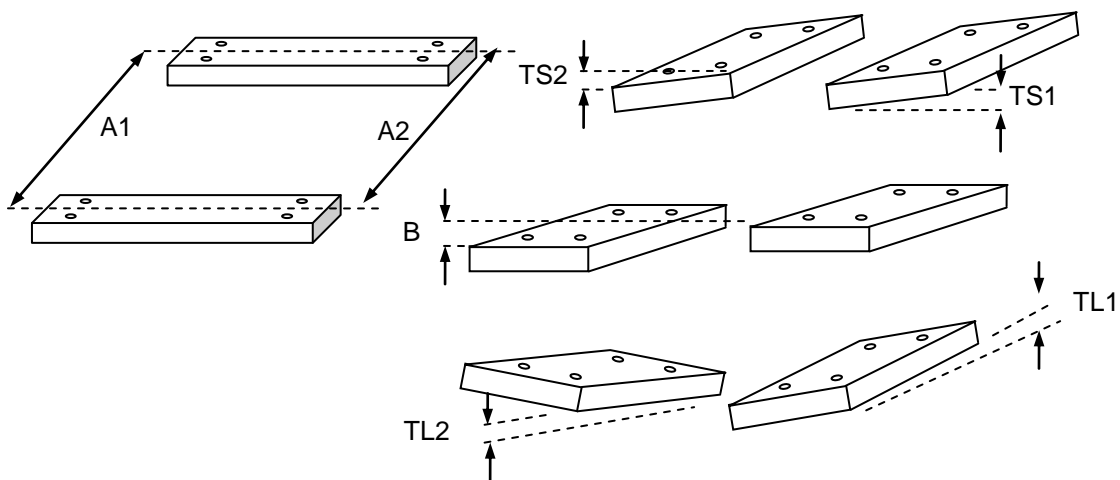

3. Fits and Tolerances in General

This section is considered from the perspective of working with couplings but includes other components fitted to shafts..

3.1 Shrink Fit vs Clearance Fit

In determining the proper fit of a hub on a shaft the question arises as to use of a clearance fit or a interference fit and, if interference, how much shrink should be used.

Normally, the coupling manufacturer should provide the information required but in the absence of this the following will assist as a guide.

3.2 Parallel Shafts

Clearance Fit (with keys and set screws) Generally, clearance fits with set screws are used on shaft up to 100mm. Torque is transmitted through the keys. Because of the likelihood of rocking with consequent fretting which can lead to failure, clearance fits are limited to relatively small power applications.

Shrink Fits A shrink fit which conforms to AGMA9002 recommendations is unlikely to rock. For standard type couplings with keys the shrink should not exceed **0.00075mm/mm**. If it is intended to drive totally through the shrink fit when a key is used, the hub may well split above the key; in such a case remove the key and go to a heavier interference.

For keyless fits the shrink needs to be sufficient to handle the normal plus transient loads which may be expected and the manufacturer should supply data. Generally, the interference will range between **0.0015mm/mm to 0.003mm/mm** but this is dependent upon the material hardness.

For a steel hub 90degC is required for every 0.001mm of interference per mm of hub diameter. For example, a hub with a 100mm bore and an interference of 0.075mm requires a differential of $0.075/100 \times 90/0.001 = 67.5\text{degC}$. If the shaft is at 22.5°C then the hub must be heated to 90°C, plus an allowance of, say, 40degC to allow for measurement errors, cooling whilst handling etc – a final temperature of 130°C.

Hubs should be heated in oil baths or ovens, not with a torch or open flame, because of distortion and material softening. Make sure there is clearance over the top of keys otherwise as the hub cools it will rest on the key with consequent high stresses and risk of failure.

3.3 Tapered Shafts

Tapered shaft have the advantage that the interference between hub and shaft can be accomplished by advancing the hub on the shaft. If the hub is advanced too far it will become overstressed. When heating is used some form of positive stop should be employed to insure correct draw up.

Draw up is achieved by heating or with nuts. Care must be taken to achieve adequate contact area, an acceptable range is 50% to 80% but 70% is a recommended minimum.

Light Interference (Under 0.0005mm/mm) When the interference is under 0.0005mm/mm the hub can usually be advanced without hearing by using the retaining nut.. A light coating of grease or anti-seize should be used.

Medium Interference (Between 0.0005 and 0.0015mm/mm) In this range heat or hydraulics will need to be employed. Care must be taken over the amount of draw up.

Heavy Interference (Above 0.0015mm/mm) The hub will normally be heated for mounting and hydraulically removed.

5. Assembly Errors

The principal area of assembly error are;

- Correct Coupling Key Length
- Correct Coupling Key Location when assembled
- Correct Set Screw Length
- Correct Coupling Bolts lengths and Washers sizes
- Burrs or Grit on Shafts or between parts
- Parallel Surfaces on Assembled Pieces
- Pulled Threads

With vertical pumps in particular it is critical that pump and motor seatings are parallel so that the shaft flanges are quite parallel. The seats must be quite clean and free from burrs or bruises which may allow the motor or pump to rock to any small degree, such small movement becomes greatly amplified in a vertical installation.

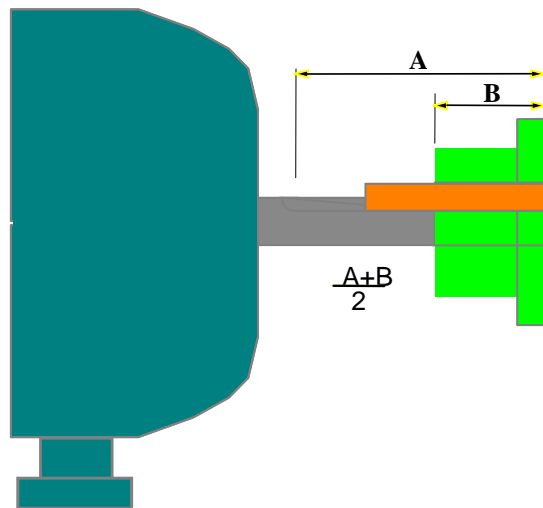

Correct Key Length for Balance

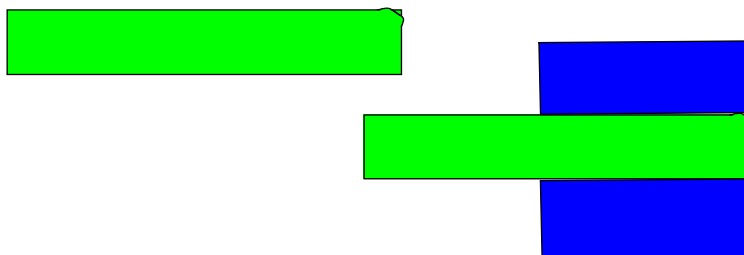

Burred and Bruised Shafts

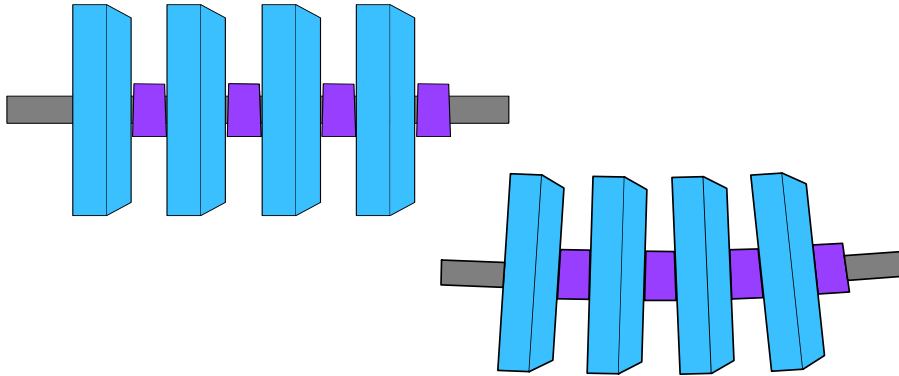

Stack Assembly Errors – Bushings not Parallel

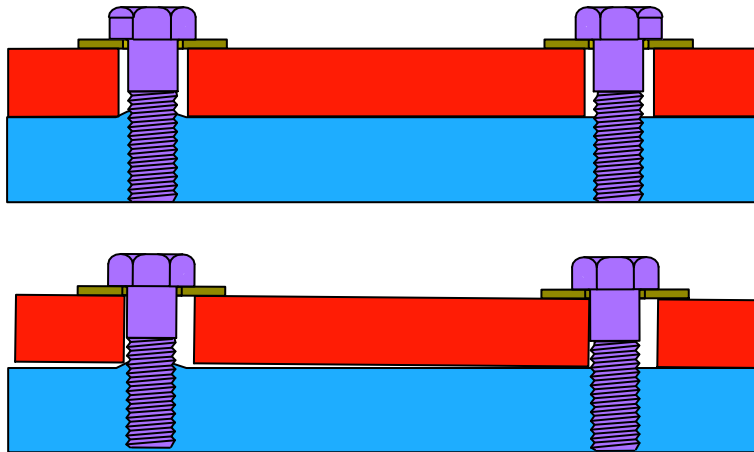

Pulled Threads – Counterbore
Cupped Washers – Replace

ITA Industrial Training Associates
Introduction to Principles of Reliability and Precision Maintenance